

形式 6000

5 t積 有ガイコンテナ

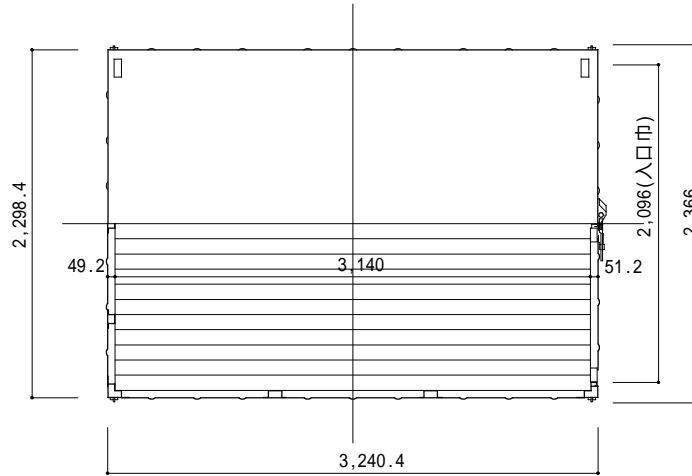

荷重	5 t
自重	約1.0 t
床面積	6.91m ²
容積	14.15m ³
製造初年	昭35

