

形式 C 2 1

5 t積 有ガイコンテナ

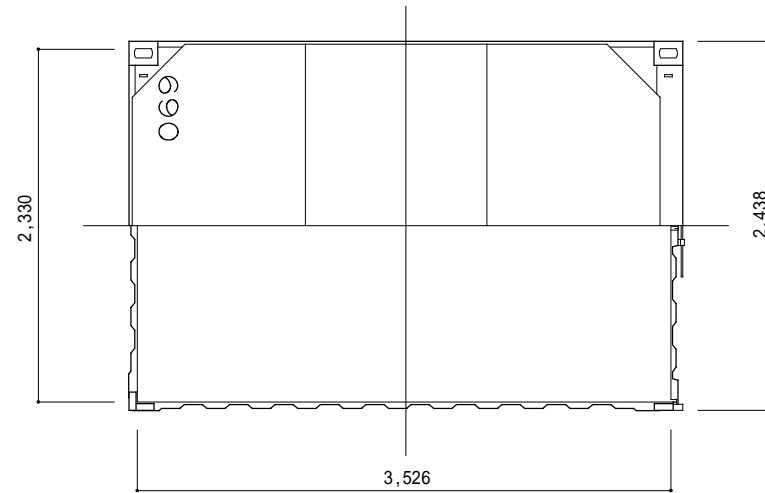

荷重	5 t
自重	約1.3 t
床面積	8.2m ²
容積	17.0m ³
製造初年	昭49

